

PURACELL VP & VPX

Mini-Pleat Series

New Product

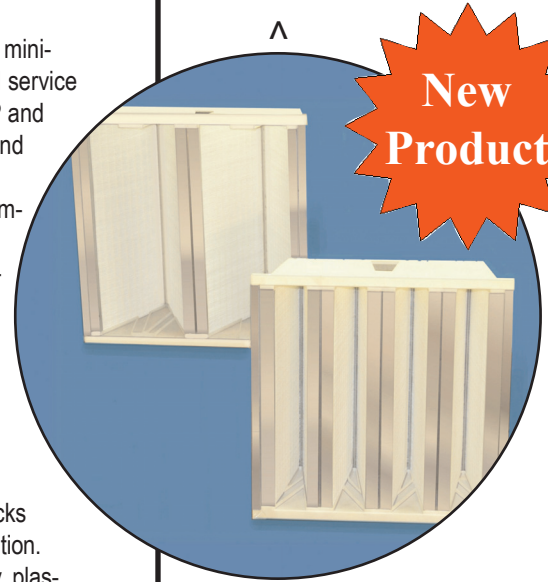

FEATURES

The Glasfloss Puracell VP and VPX Series extended surface mini-pleat filters offer high efficiency particulate removal, extended service life and extremely low resistance to air flow. The Puracell VP and VPX filters feature a versatile, plastic channel frame design and rigid galvanized struts for excellent strength and durability in demanding commercial and industrial applications. When compared to traditional rigid cell and box style filters, the Puracell VP and VPX Series offer superior performance, lower operating costs and significant energy savings. The Puracell VP and VPX Series are available in 60-65% (MERV 11) and 90-95% (MERV 14) efficiency ranges in the most common face dimensions.

CONSTRUCTION

The Puracell VP & VPX Series utilize nominal 1" mini-pleat packs which maximize the square footage of media in each configuration. The packs are strategically placed and bonded in a heavy-duty, plastic channel frame reinforced with rigid galvanized struts to prevent air bypass. The water repellent, high efficiency, microfiber media resists bacteria and mold growth.

APPLICATIONS

The Puracell VP and VPX Series are ideal for a variety of applications including hospitals, office buildings, manufacturing plants and micro-electronic component assembly. The Puracell VP and VPX are direct replacements for traditional 12" rigid cell box style filters and require no modification to the existing system.

- VP Series Features 8 Pack Construction
- VPX Series Features 4 Pack Construction
- High Efficiency Microfiber
- Low Resistance = Energy Savings
- Moisture Resistant Construction
- Lighter Weight = Reduced Shipping Cost

SPECIFICATIONS

The Puracell VP and VPX Series utilize multiple mini-pleat packs which allow low resistance to air flow and long service life. The media shall be water resistant, inorganic, wet laid glass microfiber which does not support the growth of bacteria or mold. The Puracell VP and VPX media packs are constructed by pleating a continuous sheet of media. The pleats are separated by a uniform glue bead that produces low pressure drop while maximizing the filtration area. The media packs are completely sealed and bonded within the heavy-duty injection molded plastic frame. The filters shall be rated to withstand temperatures up to 180 degrees Fahrenheit.

Efficiency	60-65%	90-95%
MERV	11	14

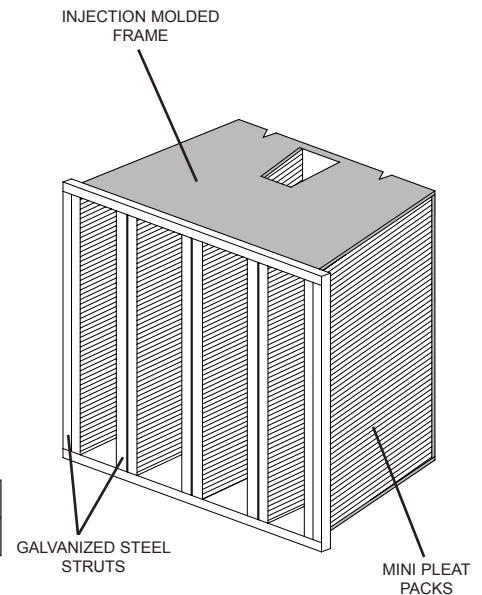

"Serving You With Locations Throughout The Nation"

Glasfloss has a policy of uninterrupted research, development and product improvement and reserves the right to change design and specifications with out notice.

PURACELL VP & VPX

Mini-Pleat Series

Puracell VP

BASE MODEL NUMBER	SIZE W x H x D NOMINAL	SIZE W x H x D EXACT	RATED VELOCITY FPM	INITIAL RESIST. IN. W.G.	FINAL RESIST. IN. W.G.	MEDIA SQUARE FEET	SIZE W x H x D NOMINAL MM
90-95% Efficiency - MERV 14							
2424B3	24 x 24 x 12	23-3/8" x 23-3/8" x 11-1/2"	500	.35	2.0	189.00	610 x 610 x 305
2420B3	24 x 20 x 12	23-3/8" x 19-3/8" x 11-1/2"	500	.35	2.0	154.00	610 x 508 x 305
2412B3	24 x 12 x 12	23-3/8" x 11-3/8" x 11-1/2"	500	.35	2.0	84.00	610 x 305 x 305

60-65% Efficiency - MERV 11							
2424B1	24 x 24 x 12	23-3/8" x 23-3/8" x 11-1/2"	500	.26	2.0	189.00	610 x 610 x 305
2420B1	24 x 20 x 12	23-3/8" x 19-3/8" x 11-1/2"	500	.26	2.0	154.00	610 x 508 x 305
2412B1	24 x 12 x 12	23-3/8" x 11-3/8" x 11-1/2"	500	.26	2.0	84.00	610 x 305 x 305

Tolerances shall be +/- 1/16" for height, width and depth. The frame depth shall not exceed 5-7/8" and 11-1/2". Performance values based on ASHRAE and in-house testing methods.

STANDARD PRESSURE DROP

Test Filter Size 24" x 24" x 12" Nominal

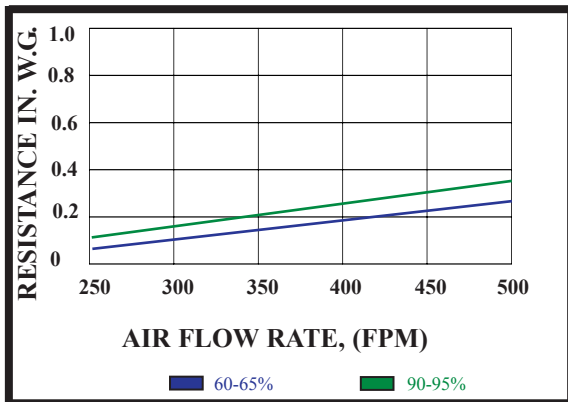

MINIMUM PARTICLE SIZE EFFICIENCY

Test Filter Size 24" x 24" x 12" Nominal

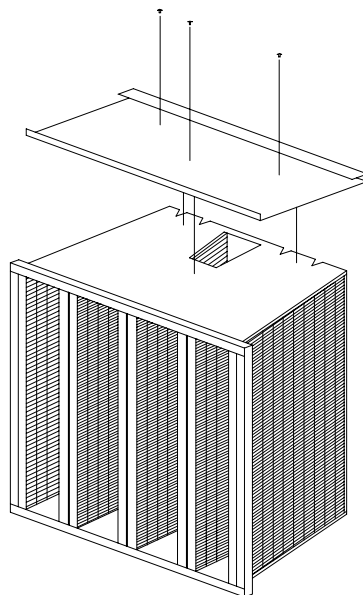
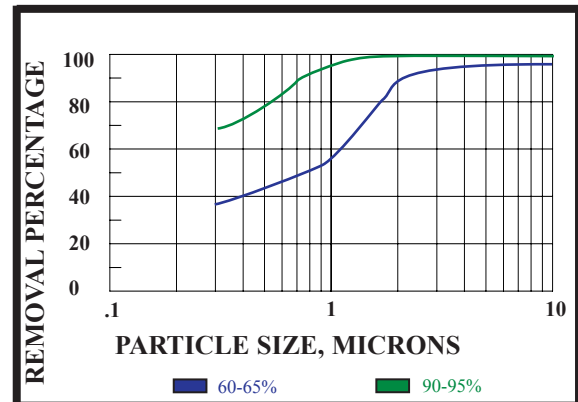

Double Header Option:

Puracell VP & VPX are available in single or double header designs. Please reference the part number configuration chart on the back page to determine correct part number.

"Serving You With Locations Throughout The Nation"

Glasfloss has a policy of uninterrupted research, development and product improvement and reserves the right to change design and specifications with out notice.

PURACELL VP & VPX

Mini-Pleat Series

Puracell VPX

BASE MODEL NUMBER	SIZE W x H x D NOMINAL	SIZE W x H x D EXACT	RATED VELOCITY FPM	INITIAL RESIST. IN. W.G.	FINAL RESIST. IN. W.G.	MEDIA SQUARE FEET	SIZE W x H x D NOMINAL MM
90-95% Efficiency - MERV 14							
2424B3	24 x 24 x 12	23-3/8" x 23-3/8" x 11-1/2"	500	.45	1.5	96.00	610 x 610 x 305
2420B3	24 x 20 x 12	23-3/8" x 19-3/8" x 11-1/2"	500	.45	1.5	78.00	610 x 508 x 305
2412B3	24 x 12 x 12	23-3/8" x 11-3/8" x 11-1/2"	500	.45	1.5	43.00	610 x 305 x 305

60-65% Efficiency - MERV 11							
2424B1	24 x 24 x 12	23-3/8" x 23-3/8" x 11-1/2"	500	.33	1.5	96.00	610 x 610 x 305
2420B1	24 x 20 x 12	23-3/8" x 19-3/8" x 11-1/2"	500	.33	1.5	78.00	610 x 508 x 305
2412B1	24 x 12 x 12	23-3/8" x 11-3/8" x 11-1/2"	500	.33	1.5	43.00	610 x 305 x 305

Tolerances shall be +/- 1/16" for height, width and depth. The frame depth shall not exceed 5-7/8" and 11-1/2". Performance values based on ASHRAE and in-house testing methods.

STANDARD PRESSURE DROP

Test Filter Size 24" x 24" x 12" Nominal

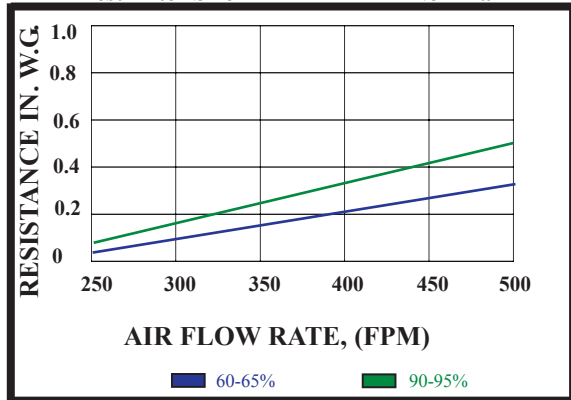

MINIMUM PARTICLE SIZE EFFICIENCY

Test Filter Size 24" x 24" x 12" Nominal

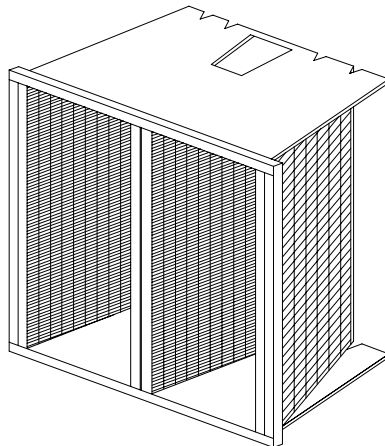
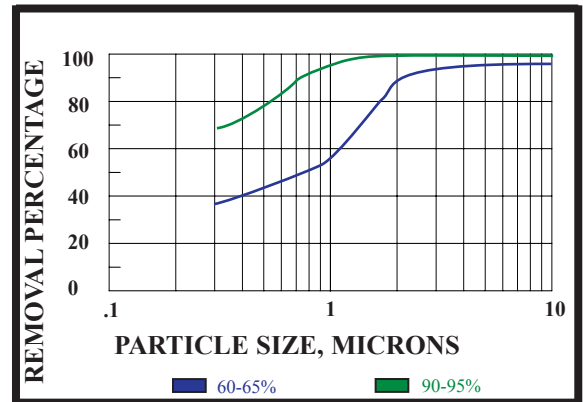

"Serving You With Locations Throughout The Nation"

Glasfloss has a policy of uninterrupted research, development and product improvement and reserves the right to change design and specifications with out notice.

Energy Savings & Environmental Impact Comparison

	<u>Glasfloss Puracell VP</u>	<u>Traditional Rigid Cell</u>
MERV Rating	14	14
Initial Resistance (in. w.g)	0.35	0.68
*Recommended Final Resistance (in. w.g.)	2.00	1.5
**Fan/Motor/Drive Efficiency (%)	58.00%	58.00%
***Energy Consumption (kWh)	2684	3876
Annual CO2 Emissions (lbs)	3629	5240
Annual Energy Cost (\$.08/kWh)	\$215.00	\$310.00

* VP pressure drop estimated at 1.17 in. w.g. after 12 months

** Fan/Motor/Drive Efficiency estimated & averaged at 58%

*** Kilowatt estimated at \$.08/kWh

Glasfloss Puracell VP = \$95.00 energy savings per filter or annually 30% savings per this comparison.

PART NUMBER CONFIGURATION FOR VP & VPX

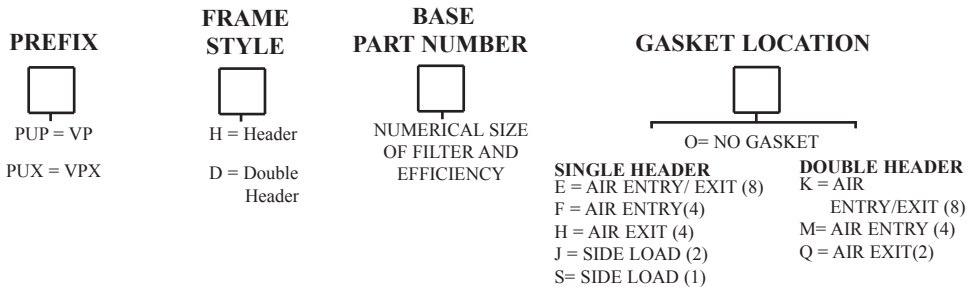

Distributed by:

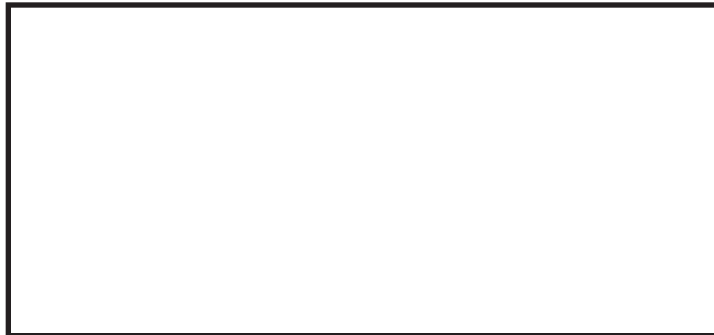

"Serving You With Locations Throughout The Nation"

Glasfloss has a policy of uninterrupted research, development and product improvement and reserves the right to change design and specifications with out notice.